



# YOUR HOME SECURITY SYSTEM **IN A BOX**

- 2.4-inch TFT colour display screen
- Support multi-language
- GSM network time automatically
- GPRS real-time networking online
- WIFI / GSM / 3G / GPRS networking alarm
- Support APP remote arm/disarm, parameter settings and accessories management
- Main interface status bar, status sticker date and clock display in real time

User Manual

[curv360.co.uk](http://curv360.co.uk)

# Contents

**Door Sensor**

**5 - 7**

**Wireless Standalone Alarm Siren**

**9 - 11**

**Wireless Anti-pet Passive Infrared Detector**

**13 - 22**

**Outdoor Multi-use Solar Powered Siren**

**24 - 31**

# Door Sensor

# Door Sensor

## Installation:

Door sensors should be installed on to the door and with either the double-sided adhesive sticker, or with the supplied screws.

1. Install part A, (the transmitter) on the fixed frame and the magnetic bar Part B (the magnet) on the door.
2. The distance between magnet and transmitter should not be more than 1 cm.

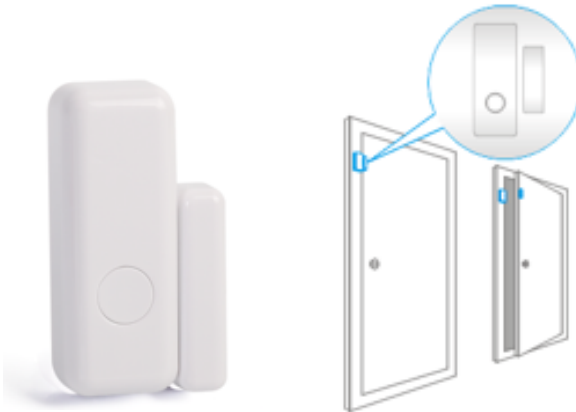

## Usage:

### 1. How to code:

In coding state, press the test button or separate the sensor body and magnetic bar to finish coding.

2. After installation, the indicator light flashes Once when opening the door, this means installation was successful.

3. Door sensor indicator light flashes every second which means the hints of alarm; Indicator light flashes 3 times which means the low power of the battery, please replace the battery the battery in time.

4. Test button can also be used as SOS button. Once press this button, the detector will immediately send alarm signal to make an alarm.

**Notes: Please check whether the signal between door sensor and alarm host is OK Before fixing the door sensor.**

## Technical Parameter:

Operating Voltage	3V button cell *1 (lithium metal battery *1)
Working current	8mA-12mA
Static current	1uA-5uA
Emission frequency	433Mhz /1527/330K
Emission Distance	100m (in open air)
Installation distance between magnetic and transmitter	≤2cm
Trigger distance	2~3cm
Working temperature	-10°C~55°C
Detection degree	110°
Dimensions	6*3.3*1.4cm

# **Wireless Standalone Alarm Siren**

## Wireless Indoor Siren

### 1. Initialization

Power the siren by power adapter or turn on the battery switch, the siren will sound and flash twice; In arm state it will flash once every 10 seconds.

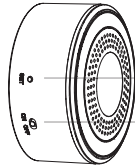
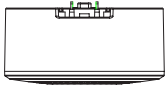
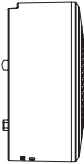
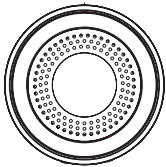

Setting key

Power Switch

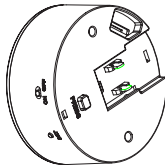
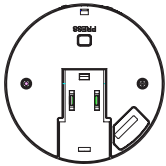

### Function Setting:

#### 1. Initialization

Once plug in and the power is on , the siren will sound and flash twice; When Set, state it will flash once every 10 seconds.



## Technique Parameter

Power output	DC12V 500mA
Standby current	≤13mA
Alarm current	≤230mA
Frequency	433MHz/315MHz
Code	SC 2262 IC / 4.7MΩ
Temperature	-20°C ~ +55°C
Humidity	40% ~ 80%RH
Backup Battery	Lithium-ion battery 7.4V/400mA

## **Maintenance**

### **System testing**

Although the alarm system is used every day, it still needs regular care, maintenance and inspection, to ensure that the alarm system will be stable, reliable and safe. Normally the standalone alarm needs a thorough inspection every 3 months and the detectors need to be checked once a month.

### **Detector testing**

1. Manually trigger the detector to check whether it alarms normally or not.
2. Check batteries of all detectors to make sure whether they are under-voltage.
3. Check whether wireless detector is communicated with the standalone alarm during emission testing.

### **Notes:**

Do not dismantle, repair and modify products privately, or may cause accidents and failures. Do not drop the product on the ground or this will invalidate the warranty.

# **Wireless Anti-pet Passive Infrared Detector**

## Simple Introduction:

This is a “new generation” wireless passive infrared detector with adoption of import ultra low power consumption microprocessor, with random dynamic time division and energy accumulation logic processing technology, with patented accurate columnar Finel lens, dual induction, adjustable pulse count, matching advanced patented software technology that can overcome false alarms from traditional detectors.

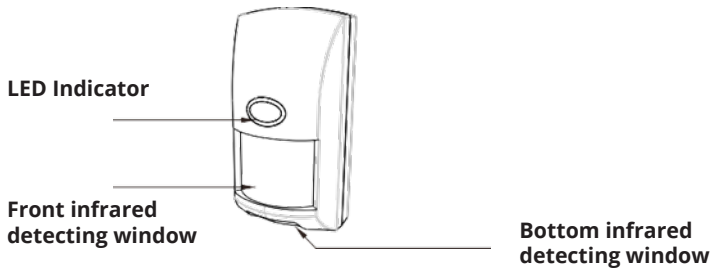

Diagram 1 for whole appearance

## Features:

- Adopting import low power consumption microprocessor & artificial intelligence
- Dual induction technology
- Dual temperature compensation technology that works well in high temperature
- Bottom detecting window that can avoid missing alarm for someone or something go inside by scrawling from underside
- Adjustable pulse count
- Adopting import high quality infrared sensor
- Random dynamic time division technology
- Finel Optics Lens to avoiding false alarms
- Built-in 1600million address code
- Anti white light intensity up to 6500lux, can make alarm even under influence from white light, it can be the leader in this industry around the world
- Detecting angle: 110 degree
- Wall installation with unique plug-in installation designed

**Specification:**

Detecting distance	12m , 25°C
Transmission distance	150m (open area)
Operating voltage	3V (2 *AA alkaline battery)
Standby current	≤10μA
Alarm current	≤11mA
Wireless frequency	433.92MHZ
Wireless transmission code	1527
Max working area	12m×12m(23×40 inches)
Alarm indicator	lasting flashing for three second
Working environment	-10°C ~+60°C
Tamper switch	keep close
Transmission method	wireless transmission

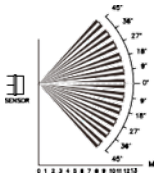

Angle detecting chart



Distance detecting chart

## Installation

Installation height	2.2-2.7 meter
Operating temperature	-20°C ~ +50°C
Storage temperature	-20°C ~ +60 °C
Anti White light influence	>10000lux (indoor)
Appearance dimension	120*62*46(mm)

## Installation attention

⚠ Please do not install in the following areas

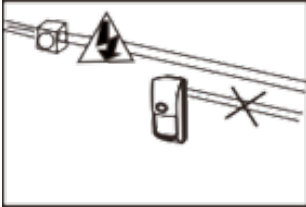

Do not Install near power cables

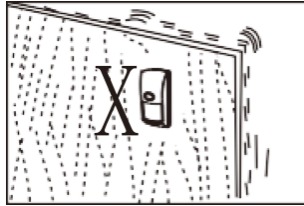

Do not fix to any movable partions

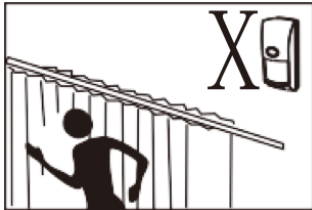

Do not Install near metal objects

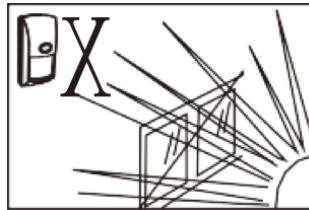

Do not Install in direct sunlight



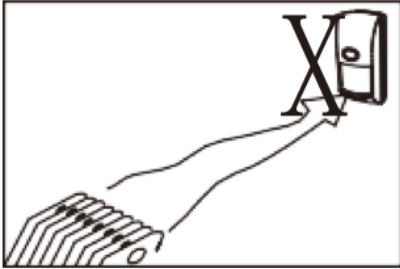

**Do not Install near convection heaters or any cooling fans**

**There are following three kinds of working modes settings**

1. Test Mode: Interval time of making alarm is five seconds, sending a monitoring signal, states of detector and battery 15 minutes interval.
2. Battery saving mode: Interval time of making alarm is three minutes, sending a monitoring signal, states of detector and battery sixty-five minutes interval.
3. Code Mode: Pressing the tamper button lasting three seconds to send an identifier to receiving alarm host

## Plunger Pin Operation

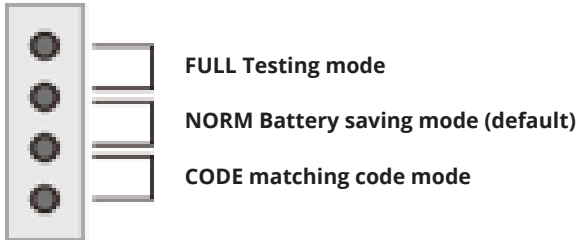

4.3 There are following three sensitivity setting

1 pulse: Alarm against detecting one pulse signal

2 pulses: Alarm against detecting two pulses signal

3 pulses: Alarm against detecting three pulses signal

Notice:

The lower pulse setting has less sensitivity giving less false alarms

## Plunger Pin Operation

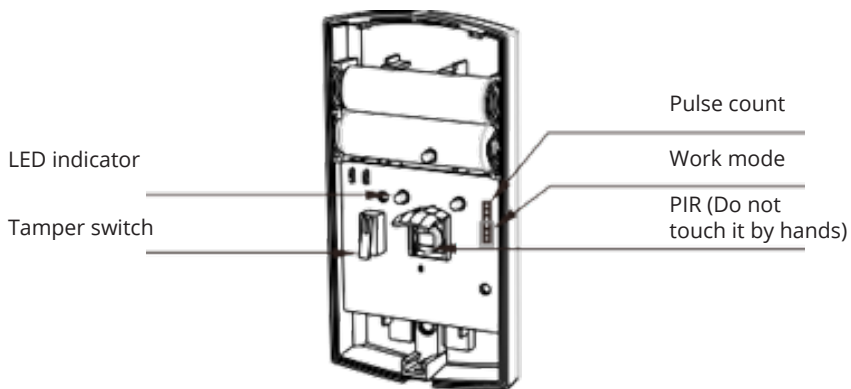
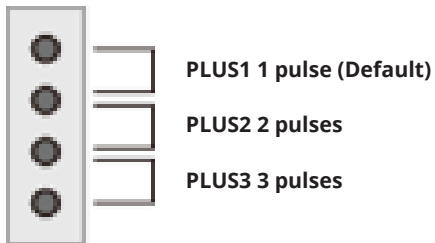
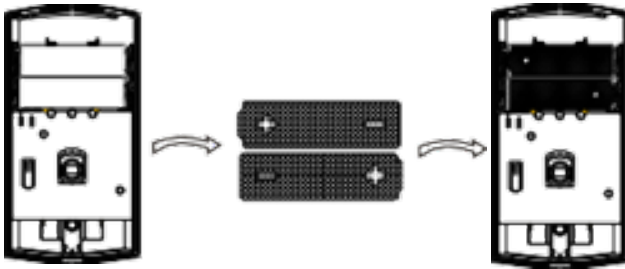

Diagram 3 for inner structure

### 4.3 How to replace batteries

The batteries need to be placed when the host was sent a low battery single, please take the detector cover off and put batteries in by matching correct positions of positive and negative (see below chart)



Replace batteries

2. Matching code with host by inputting address code, get host under code mode and input address code be set of nine figures (it can make easy success)

#### How to test the coverage range

1. Set it as test mode, pick any one of 1,2,3 as pulse according to your test intention
2. Move on from any direction within coverage range at speed of approximate 0.75m a feet, you see the LED light lasting flashing for three seconds, it means the effective detecting.
3. Move on in opposite, to make sure the monitoring area

4. You may adjust the detecting range to find out the fit position of detector installed

5. After adjusted detecting angle, please re-test it by walking

**Remark:**

**After testing, please set the test mode to default mode**

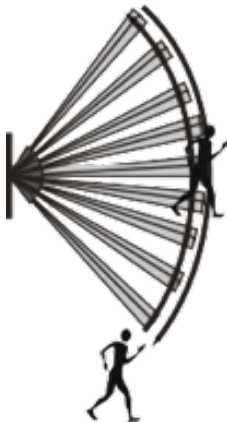

**Chart 4**

**Cleaning**

Please dust off this device with a damp cloth.

⚠ Ensure cloth is not too wet.

# **Outdoor Multi-use Solar Powered Siren**

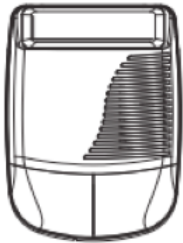

## Product Overview

Solar wireless siren uses solar energy to power the built-in battery, the siren can be controlled wireless or wired. You can add multiple wireless sirens at different locations to get alarms simultaneously to alert illegal intruders.

Wireless siren should be installed where's the best for precaution as well as the best reception for all wireless detectors. Ensure that siren is fitted away from metal objects or appliances with high frequencies.

## PCB diagram

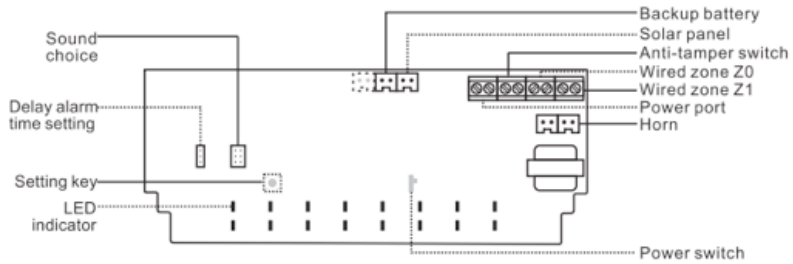

## Function Setting by jumper

Siren alarm sound setting

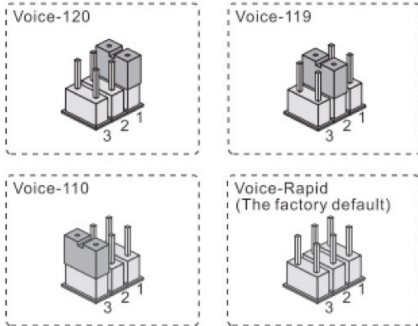



## Delay alarm time setting

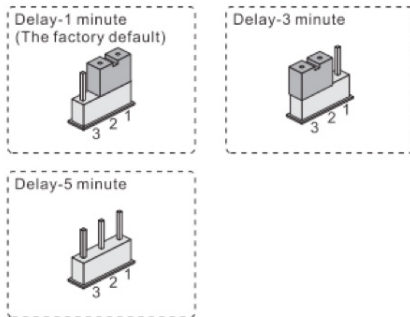

## Work as a wired siren

Solar wireless siren easily connects to alarm panel by its two wired defence zones Z0 & Z1. The siren will sound and flash when the alarm panel makes alarms



Connection diagram

## Work as a wireless siren

Solar siren needs coding with wireless alarm panel which have wireless transmission module, then it makes sounds and flashes when there is an alarm from the alarm panel. To connect alarm panel: press setting key to make out a “beep”, siren into coding state; then trigger the panel to release a wireless signal, coding successfully when you hear two “beeps”.

## Work as a live alarm system

How to code the remotes and detectors:

Press setting key to make a “beep”, siren into coding state, then trigger the remotes or detectors, coding successfully when you hear two “beeps”.

## Delete all remotes, detectors and alarm panel

Press setting keys till make two “beeps”, release the setting key to delete successfully.



## Alarm status

Arm state: In this state, all detectors can trigger it alarm.

Disarm state: In this state, none detector can trigger it alarm.

Alarm state: In this state, the siren alarm by sound and flash on spot. It will exit alarm automatically after 3 minutes if no operation, return to standby state.

## Daily Operation

Arm : press [  ] or [  ] key ( **1** or **3** ).

Disarm: press [  ] key **2**

Emergency alarm: press [ **SOS** ] key **4**

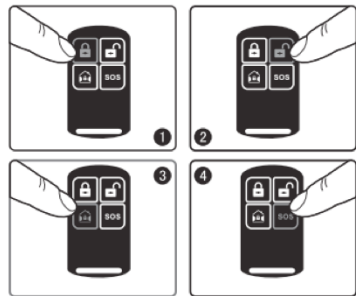

## Arm

Arm means the standalone alarm carry out all alert deployment: when no one at home, you need to place a comprehensive detection alert with the alarms on prevention spots, ensure all detectors are in working condition; when probe source (thief intrusion, fire broke out, gas leak etc.) trigger the detector, the alarm system give an alarm immediately Remote operation: press remote control [  ] key once.



## Standalone alarm disarm

Standalone alarm disarm means to let the alarms in a state of non-alert. One disarm is the normal disarm operation after arm it; another disarm is, you need to stop this alarm while after its alarming; The normal zone will not work after disarmed, except for 24-hour zones Remote operation: press remote control [  ] button once.

## SOS

Some special cases occur at home,sudden illness for the elderly or children results in first aid;in case of sudden fire, help is needed;criminals burglary muggings,at such situations,you could press [ **SOS** ] button or wireless emergency button alarm. It will immediately give an alarm,tell the host family.

Remote operation: press remote control [ **SOS** ] once.



## Installation

1. Fix the bracket with screws onto the wall.
2. Put the siren on the bracket .

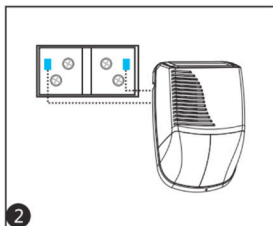
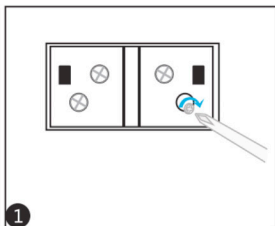

## Technical

Power supply	DC 3.7V (3.7V/400mAh rechargeable lithium ion battery)
Output max. current from solar panel	5V/150mA
max. alarm current	≤170mA
Wireless receiving distance	≥100m
Ambient Humidity	≤80%(no freezing)
Outline size	262x195x61mm
Standby current	≤1mA
Standby period	≥15days
Wireless receiving frequency	315MHz/433MHz
Operating temperature	-30~70°C
Wired defence zones	2 zones (Z0,Z1)
Anti-tamper	1(TMP)
Wireless defence zones	Total 30 with alarm panel, accessories and remotes.





cürv

[curv360.co.uk](http://curv360.co.uk)